



NFC Handheld devices



EasyNFC app



UK
CA



SELV IP66



Features:

- DT8- warm white and cool white dimming
- Constant voltage/ PWM Output (NFC regulation)
- DALI & Push dimming function (0-100%)
- AC input: 100-277VAC
- Built-in active PFC function
- Efficiency up to 93%
- Protections: Short circuit/ Over load/ Over temperature
- Cooling by free air convection
- IP66 design for indoor and outdoor installation.
- Suitable for intelligent LED lighting
- 5 year warranty

Models

ELED-150-12DP2 DT8

ELED-150-24DP2 DT8

ELED-150-48DP2 DT8

Output Specifications

	ELED-150-12DP2 DT8	ELED-150-24DP2 DT8	ELED-150-48DP2 DT8
Output Voltage	12V (12-13.5V adjust by NFC)	24V (24-26V adjust by NFC)	48V (46-50V adjust by NFC)
Voltage Tolerance		± 0.5%	
Output Current	12.5A	6.25A	3.13A
Rated Power		150W	
Load Regulation		± 1-2%	

Input Specifications

Input Voltage	100-277VAC
Frequency Range	47-63Hz
Inrush Current	38.4A, 50%, 510us @120VAC; 88A, 50%, 120us @230VAC; 48A, 50%, 560us @277VAC
Full Load Efficiency (Typ.)	92% 93.5% 93.5%
AC Current (Max.)	1.7A
Leakage Current	<0.50mA
Power Factor	PF≥0.98@120VAC PF≥0.97@230VAC PF≥0.95@277VAC (Full loading)

Protection

Short Circuit	Constant current mode, recovers automatically after fault condition is removed
Over Loading	≤120% constant current limiting, recovers automatically after fault condition is removed
Over Temperature	100°C± 10°C
Protection Class	I

Environment

Working Temperature	-40~+60°C (Refer to derating curve)
Working Humidity	20-90% RH, non-condensing

Safety & EMC

Storage Temperature, Humidity	-40~+80°C, 10-95% RH
Temperature Coefficient	±0.03%/°C (0-50°C)
Vibration	10-500Hz, 5G 10min./ 1 cycle, period for 60min.each along X, Y, Z axes

Safety & EMC

Safety standards	EN61347-1, EN61347-2-13, EN62493, IP66
Withstand voltage	I/P-O/P:3.75KVAC I/P-FG:1.88KVAC O/P-FG:0.5KVAC
Isolation resistance	I/P-O/P I/P-FG O/P-FG: 100MΩ/500VDC/25°C/70%RH
EMC Emission	Compliance to EN55015, EN61000-3-2, EN61000-3-3 (≥60% load)
EMC Immunity	Compliance to EN61000-4-2,3,4,5,6,11, EN61547

Other Specifications

Weight	1.05 Kg
Size	232x 78 x 25.1 mm
Packing	330 x 300 x 210 mm (20PCS/CTN, 22 Kg/CTN))

Mechanical Specifications

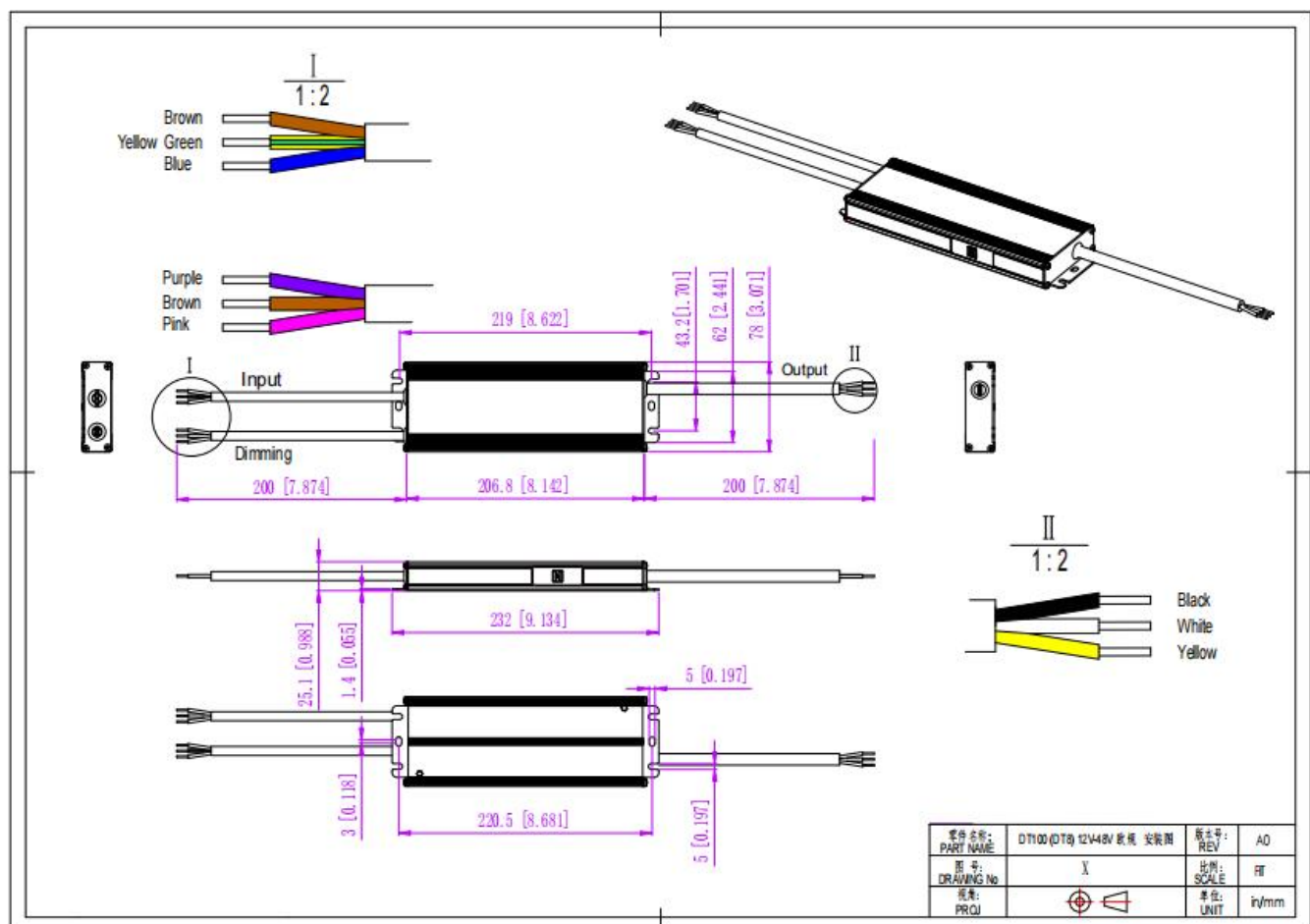

Derating Curve & whole brightness dimming Curve

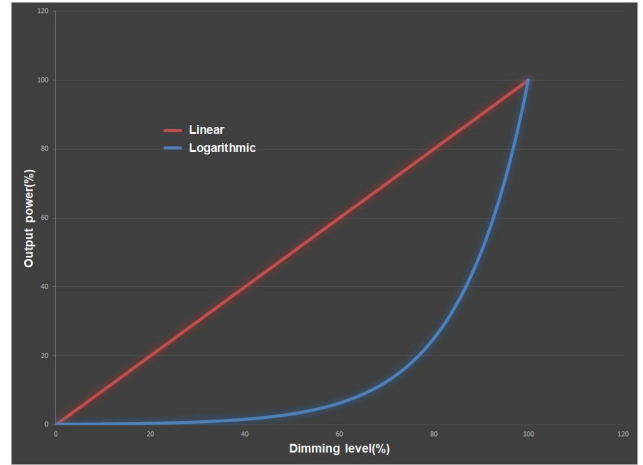
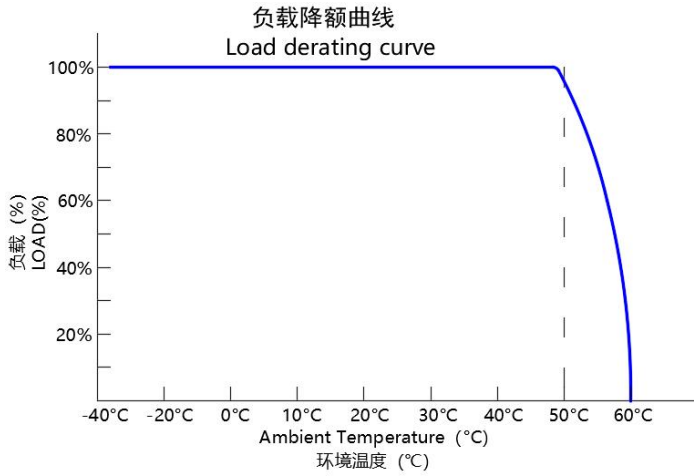

Dimming Operation

Using DALI-2 dimming with DALI power and dimmer

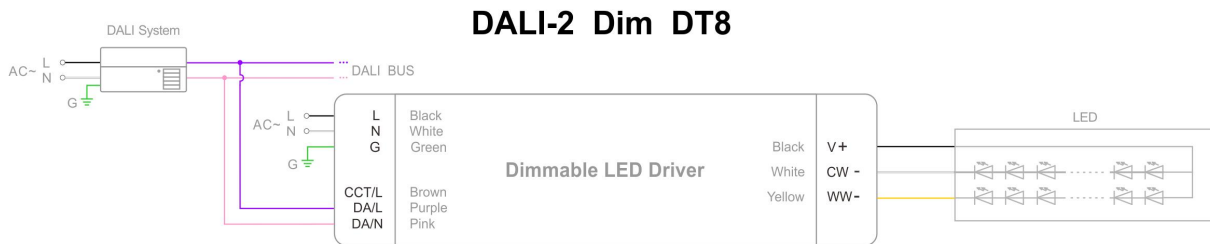

Using DALI-2 dimming with DALI system and DALI bus

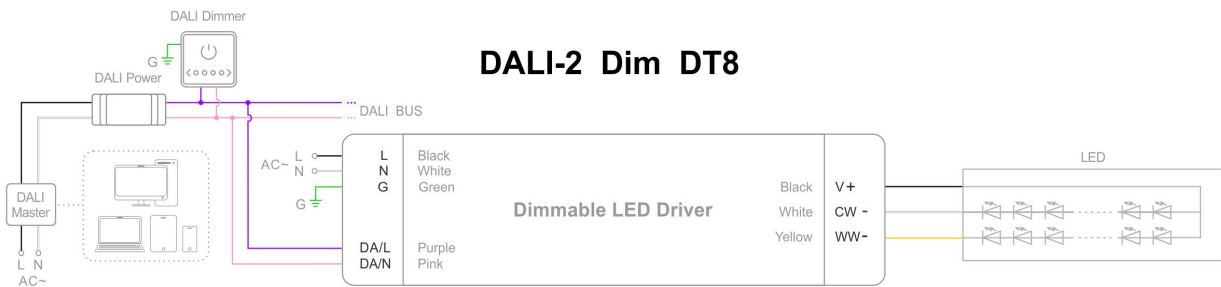

Using DALI-2 dimming with intelligent device, DALI master and dimmer

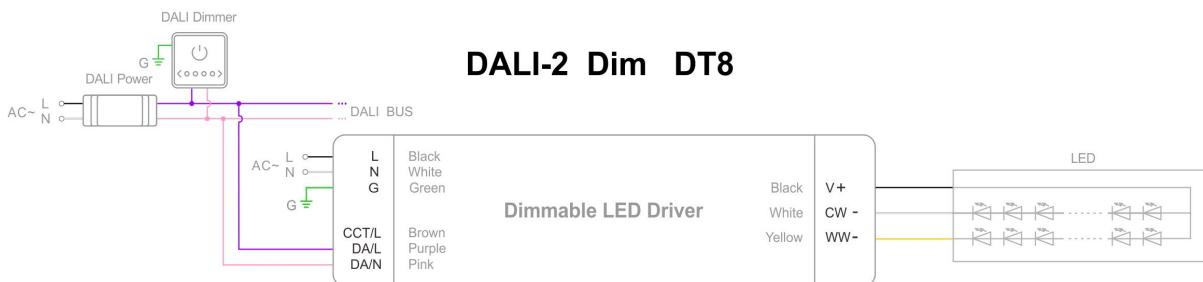

Dimming Operation

PUSH dimming with dimmer (on & off function)

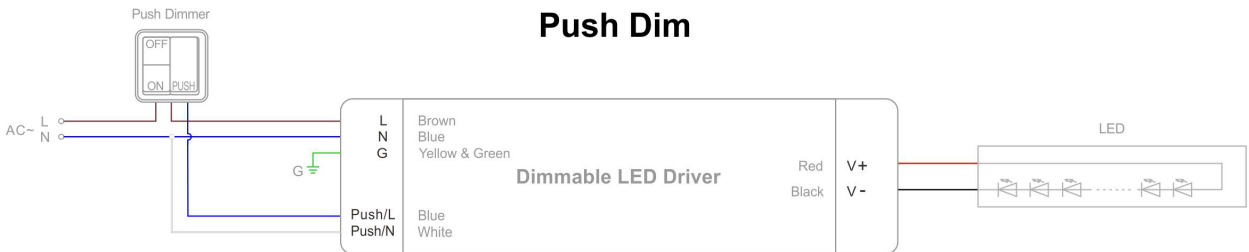
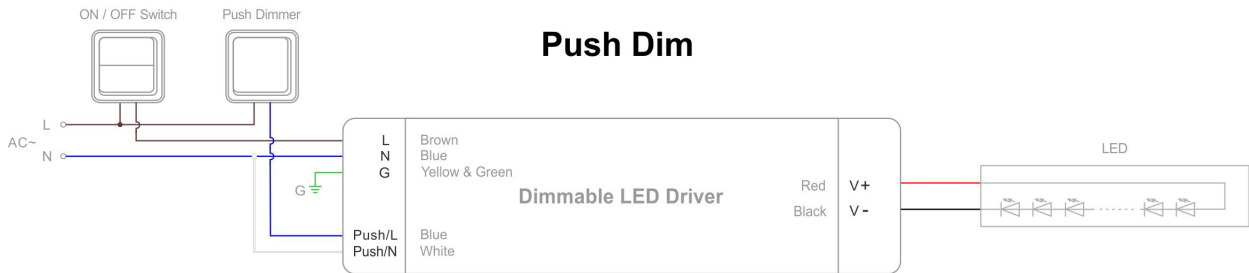

NFC Function



RDM



SetNFC APP

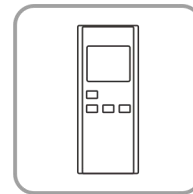

NFC Handheld devices

- Address settings:

① RDM setting address:

Set the address by the RDM device. For detailed operation, please refer to RDM device instruction manual.

② NFC setting address:

The address can be read and written by a mobile with Easy NFC APP or NFC handheld device (NFC read & write device: NFC-RW) by close to the NFC signal area of the driver.

Instruction

1. This driver should be installed by qualified and professional person.
2. Please make sure the driver is installed with adequate ventilation around it to allow for heat dissipation.
3. Ensure that wiring is correct before test in order to avoid light and power supply damage.
4. If driver Cannot work normally, don't maintain privately.