

PC T5 PRO Ip, PC TCL PRO Ip, 14 – 80 W PC PRO T5

Product description

- Highest CELMA Energy Efficiency Index A2 BAT
- Nominal life-time up to 100,000 h (at ta 50 °C with a failure rate max. 0.1 % per 1,000 h)
- Large temperature range (for values see table)
- Intelligent Voltage Guard (overvoltage indication and undervoltage shutdown)
- Precise lamp operation using adjustment of lamp parameters
- Advanced SMART-Heating for min. 50,000 starts without replacement of lamps
- Constant luminous flux irrespective of fluctuations in mains voltage
- Designed for THD < 10 %
- For luminaires of protection class I and protection class II
- Automatic start after replacement of defective lamps
- Safety shutdown of defective lamps and at end of lamp life (EOL 2)
- Insulation Displacement Connection (IDC) terminal for rapid automatic or manual wiring
- For emergency lighting systems as per EN 50172
- 5 years guarantee

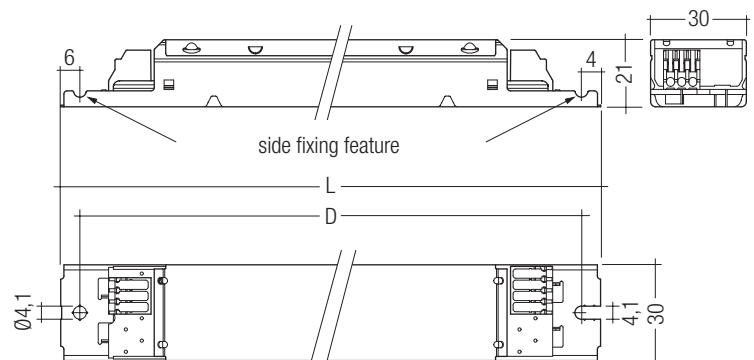

Technical data

Mains voltage range	220 – 240 V
AC voltage range	198 – 264 V
DC voltage range	176 – 280 V (lamp start \geq 198 V DC)
Mains frequency	0 / 50 / 60 Hz
Overvoltage protection	320 V AC, 1 h
Defined warm start	\leq 1.5 s
Operating frequency	\geq 39.5 kHz
Type of protection	IP20

Ordering data

Type	Article number	Packaging carton	Packaging pallet	Weight per pc.
For luminaires with 1 lamp				
PC 1x14-35 T5 PRO Ip	22185147	10 pc(s).	960 pc(s).	0.169 kg
PC 1x24 T5 PRO Ip	22185149	10 pc(s).	960 pc(s).	0.165 kg
PC 1x39 T5 PRO Ip	22185151	10 pc(s).	960 pc(s).	0.165 kg
PC 1x49 T5 PRO Ip	22185153	10 pc(s).	960 pc(s).	0.170 kg
PC 1x54 T5 PRO Ip	22185155	10 pc(s).	960 pc(s).	0.170 kg
PC 1x80 T5 PRO Ip	22185209	10 pc(s).	960 pc(s).	0.198 kg
For luminaires with 2 lamps				
PC 2x14-35 T5 PRO Ip	22185148	10 pc(s).	760 pc(s).	0.243 kg
PC 2x24 T5 PRO Ip	22185150	10 pc(s).	760 pc(s).	0.210 kg
PC 2x39 T5 PRO Ip	22185152	10 pc(s).	760 pc(s).	0.235 kg
PC 2x49 T5 PRO Ip	22185154	10 pc(s).	760 pc(s).	0.246 kg
PC 2x54 T5 PRO Ip	22185156	10 pc(s).	760 pc(s).	0.241 kg
PC 2x80 T5 PRO Ip	22185210	10 pc(s).	640 pc(s).	0.335 kg
PC 2x55 TCL PRO Ip	22185286	10 pc(s).	760 pc(s).	0.244 kg
For luminaires with 3 or 4 lamps				
PC 3/4x14 T5 PRO Ip	22185211	10 pc(s).	760 pc(s).	0.239 kg
PC 3/4x24 T5 PRO Ip	22185212	10 pc(s).	760 pc(s).	0.249 kg



Standards, page 3

Wiring diagrams and installation examples, page 7

Specific technical data

Lamp wattage	Lamp type	Type	Article number	Dimensions L x W x H	Hole spacing D	Lamp power	Circuit power	EEI	Current at 50 Hz		λ at 50 Hz		tc point max.	Ambient temperature ta	tc/ta for ≥ 50.000 h
									220 V	240 V	220 V	240 V			
For luminaires with 1 lamp															
1 x 14 W	T5	PC 1x14-35 T5 PRO Ip	22185147	280 x 30 x 21 mm	270 mm	14.7 W	16.7 W	A2 BAT	0.075 A	0.069 A	0.97	0.95	85 °C	-25 ... 80 °C	80/75 °C
1 x 21 W	T5	PC 1x14-35 T5 PRO Ip	22185147	280 x 30 x 21 mm	270 mm	20.6 W	22.4 W	A2 BAT	0.101 A	0.092 A	0.97	0.95	85 °C	-25 ... 75 °C	80/70 °C
1 x 28 W	T5	PC 1x14-35 T5 PRO Ip	22185147	280 x 30 x 21 mm	270 mm	27.9 W	30.4 W	A2 BAT	0.137 A	0.123 A	0.98	0.96	85 °C	-25 ... 75 °C	80/70 °C
1 x 35 W	T5	PC 1x14-35 T5 PRO Ip	22185147	280 x 30 x 21 mm	270 mm	35.5 W	37.8 W	A2 BAT	0.170 A	0.153 A	0.99	0.97	80 °C	-25 ... 65 °C	75/60 °C
1 x 24 W	T5	PC 1x24 T5 PRO Ip	22185149	280 x 30 x 21 mm	270 mm	22.5 W	24.8 W	A2 BAT	0.110 A	0.100 A	0.98	0.96	80 °C	-25 ... 70 °C	75/65 °C
1 x 24 W	TC-L	PC 1x24 T5 PRO Ip	22185149	280 x 30 x 21 mm	270 mm	22.5 W	24.8 W	A2 BAT	0.110 A	0.100 A	0.98	0.96	80 °C	-25 ... 70 °C	75/65 °C
1 x 39 W	T5	PC 1x39 T5 PRO Ip	22185151	280 x 30 x 21 mm	270 mm	38.0 W	40.2 W	A2 BAT	0.185 A	0.166 A	0.98	0.96	85 °C	-25 ... 70 °C	75/60 °C
1 x 49 W	T5	PC 1x49 T5 PRO Ip	22185153	280 x 30 x 21 mm	270 mm	49.2 W	52.2 W	A2 BAT	0.235 A	0.211 A	0.98	0.96	80 °C	-25 ... 60 °C	75/55 °C
1 x 54 W	T5	PC 1x54 T5 PRO Ip	22185155	280 x 30 x 21 mm	270 mm	54.1 W	57.0 W	A2 BAT	0.254 A	0.230 A	0.98	0.96	80 °C	-25 ... 60 °C	70/50 °C
1 x 80 W	T5	PC 1x80 T5 PRO Ip	22185209	280 x 30 x 21 mm	270 mm	79.8 W	85.4 W	A2 BAT	0.396 A	0.363 A	0.99	0.97	80 °C	-25 ... 60 °C	75/55 °C
1 x 55 W	TC-L	PC 1x80 T5 PRO Ip	22185209	280 x 30 x 21 mm	270 mm	55.0 W	58.9 W	A2 BAT	0.273 A	0.250 A	0.99	0.97	80 °C	-25 ... 65 °C	75/60 °C
For luminaires with 2 lamps															
2 x 14 W	T5	PC 2x14-35 T5 PRO Ip	22185148	360 x 30 x 21 mm	350 mm	29.4 W	32.2 W	A2 BAT	0.143 A	0.130 A	0.97	0.95	85 °C	-25 ... 75 °C	80/70 °C
2 x 21 W	T5	PC 2x14-35 T5 PRO Ip	22185148	360 x 30 x 21 mm	350 mm	41.2 W	46.2 W	A2 BAT	0.204 A	0.186 A	0.97	0.95	85 °C	-25 ... 70 °C	80/65 °C
2 x 28 W	T5	PC 2x14-35 T5 PRO Ip	22185148	360 x 30 x 21 mm	350 mm	55.8 W	60.2 W	A2 BAT	0.277 A	0.249 A	0.98	0.96	80 °C	-25 ... 60 °C	75/55 °C
2 x 35 W	T5	PC 2x14-35 T5 PRO Ip	22185148	360 x 30 x 21 mm	350 mm	71.0 W	76.0 W	A2 BAT	0.342 A	0.309 A	0.99	0.97	80 °C	-25 ... 55 °C	75/50 °C
2 x 24 W	T5	PC 2x24 T5 PRO Ip	22185150	360 x 30 x 21 mm	350 mm	45.0 W	48.5 W	A2 BAT	0.218 A	0.196 A	0.98	0.96	85 °C	-25 ... 70 °C	75/60 °C
2 x 24 W	TC-L	PC 2x24 T5 PRO Ip	22185150	360 x 30 x 21 mm	350 mm	45.0 W	48.5 W	A2 BAT	0.218 A	0.196 A	0.98	0.96	85 °C	-25 ... 70 °C	75/60 °C
2 x 39 W	T5	PC 2x39 T5 PRO Ip	22185152	360 x 30 x 21 mm	350 mm	76.0 W	83.2 W	A2 BAT	0.371 A	0.333 A	0.98	0.96	80 °C	-25 ... 60 °C	70/50 °C
2 x 49 W	T5	PC 2x49 T5 PRO Ip	22185154	360 x 30 x 21 mm	350 mm	98.4 W	106.0 W	A2 BAT	0.477 A	0.428 A	0.99	0.97	80 °C	-25 ... 55 °C	75/50 °C
2 x 54 W	T5	PC 2x54 T5 PRO Ip	22185156	360 x 30 x 21 mm	350 mm	108.2 W	113.5 W	A2 BAT	0.518 A	0.465 A	0.99	0.97	80 °C	-25 ... 55 °C	75/50 °C
2 x 80 W	T5	PC 2x80 T5 PRO Ip	22185210	425 x 30 x 21 mm	415 mm	159.6 W	171.4 W	A2 BAT	0.787 A	0.721 A	0.99	0.98	85 °C	-25 ... 55 °C	80/50 °C
2 x 55 W	TC-L	PC 2x55 TCL PRO Ip	22185286	360 x 30 x 21 mm	350 mm	110.0 W	119.0 W	A2 BAT	0.536 A	0.491 A	0.99	0.99	80 °C	-25 ... 55 °C	75/50 °C
For luminaires with 3 or 4 lamps															
3 x 14 W	T5	PC 3/4x14 T5 PRO Ip	22185211	360 x 30 x 21 mm	350 mm	42.0 W	47.0 W	A2 BAT	0.218 A	0.200 A	0.99	0.97	75 °C	-25 ... 60 °C	70/55 °C
4 x 14 W	T5	PC 3/4x14 T5 PRO Ip	22185211	360 x 30 x 21 mm	350 mm	53.2 W	61.7 W	A2 BAT	0.292 A	0.268 A	0.99	0.97	75 °C	-25 ... 55 °C	70/50 °C
3 x 24 W	T5	PC 3/4x24 T5 PRO Ip	22185212	360 x 30 x 21 mm	350 mm	70.9 W	75.0 W	A2 BAT	0.348 A	0.319 A	0.99	0.97	80 °C	-25 ... 60 °C	75/55 °C
3 x 24 W	TC-L	PC 3/4x24 T5 PRO Ip	22185212	360 x 30 x 21 mm	350 mm	70.9 W	75.0 W	A2 BAT	0.348 A	0.319 A	0.99	0.97	80 °C	-25 ... 60 °C	75/55 °C
4 x 24 W	T5	PC 3/4x24 T5 PRO Ip	22185212	360 x 30 x 21 mm	350 mm	90.0 W	97.5 W	A2 BAT	0.452 A	0.415 A	0.99	0.97	80 °C	-25 ... 55 °C	75/50 °C
4 x 24 W	TC-L	PC 3/4x24 T5 PRO Ip	22185212	360 x 30 x 21 mm	350 mm	90.0 W	97.5 W	A2 BAT	0.452 A	0.415 A	0.99	0.97	80 °C	-25 ... 55 °C	75/50 °C

Standards

EN 55015
EN 61347-2-3
EN 60929
EN 61000-3-2
EN 61000-3-3
EN 61547
in accordance with EN 50172
IEC 60068-2-64 Fh
IEC 60068-2-29 Eb
IEC 60068-2-30

Lamp starting characteristics

Warm start
Starting time 1.5 s with AC and DC operation
Cathode heating will be strongly reduced after pre-heat time

Lamp operation

xitec II is the new benchmark in precise lamp operation. During the manufacturing process at Tridonic the ballasts are adjusted to optimum values. This reduces tolerances to a minimum and enables a very precise fix-frequent (equivalent to current controlled) lamp operation.

AC operation

Mains voltage:
220 – 240 V 50/60 Hz
198 – 264 V 50/60 Hz including safety tolerance ($\pm 10\%$)
202 – 254 V 50/60 Hz including performance tolerance ($+6\% / -8\%$)

DC operation

220 – 240 V 0 Hz
198 – 280 V 0 Hz certain lamp start
176 – 280 V 0 Hz operating range
Light output level in DC operation: 100 %

Emergency lighting

Use in emergency lighting installations according to EN 50172 or for emergency luminaires according to EN 61347-2-3 appendix J. Instant start after mains interruption < 0.5 s
EBLF ≥ 0.5
Mains current for defective or missing lamps at DC operation < 5 mA

Intelligent Voltage Guard

Intelligent Voltage Guard is the name of an electronic monitor from Tridonic. This innovative feature of the PC PRO family of control gear from Tridonic immediately shows if the mains voltage rises above or falls below certain thresholds. Measures can then be taken quickly to prevent damage to the control gear.

- If the mains voltage rises above ≥ 280 V the lamps flash.
- This signal "demands" disconnection of the power supply to the lighting system.
- If the mains voltage falls below 130 V the control gear automatically disconnects the lamp circuit (light off) to protect the control gear from being irreparably damaged.

Mains currents in DC operation

Type	lamp type	wattage	mains current at	
			$U_n = 220 V_{DC}$	$U_n = 240 V_{DC}$
PC 1x14-35 T5 PRO Ip	T5	1x14 W	75 mA	69 mA
	T5	1x21 W	101 mA	92 mA
	T5	1x28 W	137 mA	123 mA
PC 1x24 T5 PRO Ip	T5	1x35 W	170 mA	153 mA
	T5	1x24 W	110 mA	100 mA
PC 1x39 T5 PRO Ip	TC-L	1x24 W	110 mA	100 mA
	T5	1x39 W	185 mA	166 mA
PC 1x49 T5 PRO Ip	T5	1x49 W	235 mA	211 mA
PC 1x54 T5 PRO Ip	T5	1x54 W	254 mA	230 mA
PC 1x80 T5 PRO Ip	T5	1x80 W	396 mA	363 mA
	TC-L	1x55 W	273 mA	250 mA
PC 2x14-35 T5 PRO Ip	T5	2x14 W	143 mA	130 mA
	T5	2x21 W	204 mA	186 mA
	T5	2x28 W	277 mA	249 mA
	T5	2x35 W	342 mA	309 mA
PC 2x24 T5 PRO Ip	T5	2x24 W	218 mA	196 mA
	TC-L	2x24 W	218 mA	196 mA
PC 2x39 T5 PRO Ip	T5	2x39 W	371 mA	333 mA
PC 2x49 T5 PRO Ip	T5	2x49 W	477 mA	428 mA
PC 2x54 T5 PRO Ip	T5	2x54 W	518 mA	465 mA
PC 2x80 T5 PRO Ip	T5	2x80 W	787 mA	721 mA
PC 2x55 TCL PRO Ip	TC-L	2x55 W	536 mA	491 mA
PC 3/4x14 T5 PRO Ip	T5	3x14 W	218 mA	200 mA
	T5	4x14 W	292 mA	268 mA
PC 3/4x24 T5 PRO Ip	T5	3x24 W	348 mA	319 mA
	TC-L	3x24 W	348 mA	319 mA
	T5	4x24 W	452 mA	415 mA
	TC-L	4x24 W	452 mA	415 mA

Harmonic distortion in the mains supply

Type	lamp type	wattage	THD
			at 230 V/50 Hz
PC 1x14-35 T5 PRO Ip	T5	1x14 W	$< 10\%$
	T5	1x21 W	$< 10\%$
	T5	1x28 W	$< 10\%$
PC 1x24 T5 PRO Ip	T5	1x35 W	$< 10\%$
	T5	1x24 W	$< 10\%$
PC 1x39 T5 PRO Ip	TC-L	1x24 W	$< 10\%$
	T5	1x39 W	$< 10\%$
PC 1x49 T5 PRO Ip	T5	1x49 W	$< 10\%$
PC 1x54 T5 PRO Ip	T5	1x54 W	$< 10\%$
PC 1x80 T5 PRO Ip	T5	1x80 W	$< 10\%$
	TC-L	1x55 W	$< 10\%$
PC 2x14-35 T5 PRO Ip	T5	2x14 W	$< 15\%$
	T5	2x21 W	$< 10\%$
	T5	2x28 W	$< 10\%$
	T5	2x35 W	$< 10\%$
PC 2x24 T5 PRO Ip	T5	2x24 W	$< 10\%$
	TC-L	2x24 W	$< 10\%$
PC 2x39 T5 PRO Ip	T5	2x39 W	$< 10\%$
PC 2x49 T5 PRO Ip	T5	2x49 W	$< 10\%$
PC 2x54 T5 PRO Ip	T5	2x54 W	$< 10\%$
PC 2x80 T5 PRO Ip	T5	2x80 W	$< 10\%$
PC 2x55 TCL PRO Ip	TC-L	2x55 W	$< 10\%$
PC 3/4x14 T5 PRO Ip	T5	3x14 W	$< 10\%$
	T5	4x14 W	$< 10\%$
PC 3/4x24 T5 PRO Ip	T5	3x24 W	$< 10\%$
	TC-L	3x24 W	$< 10\%$
	T5	4x24 W	$< 10\%$
	TC-L	4x24 W	$< 10\%$

Advanced SMART-Heating

PC PRO with SMART-heating ignition technology optimises lamp start and ensures no energy is wasted. After the lamp has struck the filament heating is reduced automatically to a defined minimum value. This reduction in filament heating, saves energy, yet maintains the proper operating conditions for the lamp. The lamp is always operated within specification.

Output voltage

Type	lamp type	wattage	U _{out}
PC 1x14-35 T5 PRO Ip	T5	1x14 W	430 V
	T5	1x21 W	430 V
	T5	1x28 W	430 V
PC 1x24 T5 PRO Ip	T5	1x35 W	430 V
	TC-L	1x24 W	430 V
PC 1x39 T5 PRO Ip	T5	1x39 W	430 V
PC 1x49 T5 PRO Ip	T5	1x49 W	430 V
PC 1x54 T5 PRO Ip	T5	1x54 W	430 V
PC 1x80 T5 PRO Ip	T5	1x80 W	430 V
	TC-L	1x55 W	430 V
PC 2x14-35 T5 PRO Ip	T5	2x14 W	430 V
	T5	2x21 W	430 V
	T5	2x28 W	430 V
	T5	2x35 W	430 V
PC 2x24 T5 PRO Ip	T5	2x24 W	430 V
	TC-L	2x24 W	430 V
PC 2x39 T5 PRO Ip	T5	2x39 W	430 V
PC 2x49 T5 PRO Ip	T5	2x49 W	430 V
PC 2x54 T5 PRO Ip	T5	2x54 W	430 V
PC 2x80 T5 PRO Ip	T5	2x80 W	430 V
PC 2x55 TCL PRO Ip	TC-L	2x55 W	400 V
PC 3/4x14 T5 PRO Ip	T5	3x14 W	430 V
	T5	4x14 W	430 V
PC 3/4x24 T5 PRO Ip	T5	3x24 W	430 V
	TC-L	3x24 W	430 V
	T5	4x24 W	430 V
	TC-L	4x24 W	430 V

Ballast lumen factor (EN 60929 8.1)

Type	lamp type	wattage	AC/DC-BLF at U = 198–254V, 25 °C
PC 1x14-35 T5 PRO Ip	T5	1x14 W	1.05
	T5	1x21 W	1.00
	T5	1x28 W	1.00
	T5	1x35 W	1.00
PC 1x24 T5 PRO Ip	T5	1x24 W	1.00
	TC-L	1x24 W	1.00
PC 1x39 T5 PRO Ip	T5	1x39 W	1.00
PC 1x49 T5 PRO Ip	T5	1x49 W	1.00
PC 1x54 T5 PRO Ip	T5	1x54 W	1.00
PC 1x80 T5 PRO Ip	T5	1x80 W	1.00
	TC-L	1x55 W	1.00
PC 2x14-35 T5 PRO Ip	T5	2x14 W	1.05
	T5	2x21 W	1.05
	T5	2x28 W	1.00
	T5	2x35 W	1.00
PC 2x24 T5 PRO Ip	T5	2x24 W	1.00
	TC-L	2x24 W	1.00
PC 2x39 T5 PRO Ip	T5	2x39 W	1.00
PC 2x49 T5 PRO Ip	T5	2x49 W	1.00
PC 2x54 T5 PRO Ip	T5	2x54 W	1.02
PC 2x80 T5 PRO Ip	T5	2x80 W	1.00
PC 2x55 TCL PRO Ip	TC-L	2x55 W	1.00
PC 3/4x14 T5 PRO Ip	T5	3x14 W	1.05
	T5	4x14 W	1.00
PC 3/4x24 T5 PRO Ip	T5	3x24 W	1.05
	TC-L	3x24 W	1.05
	T5	4x24 W	1.00
	TC-L	4x24 W	1.00

PC PRO with xitec II processor

Is the very latest in lighting management design technology. The lamp friendly warm start is delivering maximum lamp life and enables high switching frequency applications. Smallest power loss and new freedom in the lamp design thanks to convincing thermal management.

Energy class: CELMA EEI = A2 BAT¹⁾

Maximum energy efficiency:

Right from the early stages in the development of xitec II technology the focus has always been on achieving maximum energy efficiency. In conjunction with SMART-Heating Technology, PC PRO is rated in the best possible efficiency class of A2 BAT that CELMA provides for ballasts with a constant luminous flux.

Ambient temperature

PC 1x... T5 PRO Ip

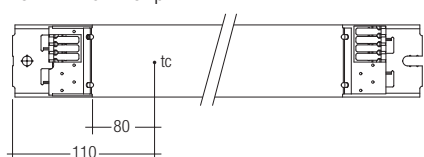

PC 2x... T5 PRO Ip (except PC 2x80 T5 PRO Ip)

PC 2x... TCL PRO Ip

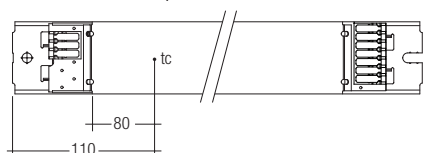

PC 2x80 T5 PRO Ip

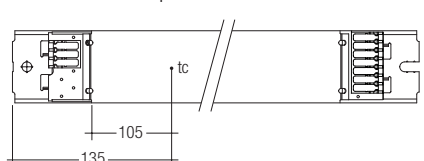

PC 3/4x... T5 PRO Ip

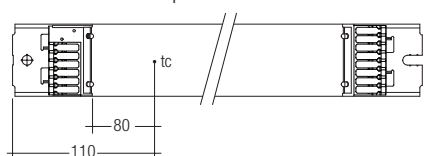

The nominal ta and tc point are related to the ballast life duration.

The relation of tc to ta temperature depends also on the luminaire design. If the measured tc temperature is approx. 5 K below tc max., ta temperature should be checked and eventually critical components (e.g. ELCAP) measured.

Detailed information on request.

PC T5 PRO Ip is designed for an average life-time of 100,000 h (at ta for ≥ 100,000 h) under reference conditions and with a failure probability of less than 10 %. This corresponds to an average failure rate of 0.1 % for every 1,000 h of operation.

Humidity: 5 % up to max. 85 %, not condensed (max. 56 days/year at 85 %)

Storage temperature: -40 °C up to max. +80 °C

The devices have to be within the specified temperature range (ta) before they can be operated.

¹⁾ according to the EU directives on ecodesign requirements (EC) No. 245/2009 and (EC) No. 347/2010

Expected life-time

Type	Lamp type	Lamp power	ta	40 °C	50 °C	55 °C	60 °C	65 °C	70 °C	75 °C	80 °C
PC 1x14-35 T5 PRO Ip	T5	1x14 W	tc	45 °C	55 °C	60 °C	65 °C	70 °C	75 °C	80 °C	85 °C
			Life-time	> 100,000 h	> 100,000 h	> 100,000 h	> 100,000 h	> 100,000 h	85,000 h	60,000 h	40,000 h
		1x21 W	tc	50 °C	60 °C	65 °C	70 °C	75 °C	80 °C	85 °C	x
			Life-time	> 100,000 h	> 100,000 h	> 100,000 h	> 100,000 h	80,000 h	55,000 h	40,000 h	x
		1x28 W	tc	50 °C	60 °C	65 °C	70 °C	75 °C	80 °C	85 °C	x
			Life-time	> 100,000 h	> 100,000 h	> 100,000 h	> 100,000 h	75,000 h	50,000 h	35,000 h	x
		1x35 W	tc	55 °C	65 °C	70 °C	75 °C	80 °C	x	x	x
			Life-time	> 100,000 h	> 100,000 h	100,000 h	70,000 h	45,000 h	x	x	x
PC 1x24 T5 PRO Ip	T5	1x24 W	tc	50 °C	60 °C	65 °C	70 °C	75 °C	80 °C	x	x
			Life-time	> 100,000 h	> 100,000 h	100,000 h	85,000 h	60,000 h	40,000 h	x	x
	TC-L	1x24 W	tc	50 °C	60 °C	65 °C	70 °C	75 °C	80 °C	x	x
			Life-time	> 100,000 h	> 100,000 h	100,000 h	85,000 h	60,000 h	40,000 h	x	x
PC 1x39 T5 PRO Ip	T5	1x39 W	tc	55 °C	65 °C	70 °C	75 °C	80 °C	85 °C	x	x
			Life-time	> 100,000 h	> 100,000 h	80,000 h	60,000 h	40,000 h	30,000 h	x	x
PC 1x49 T5 PRO Ip	T5	1x49 W	tc	60 °C	70 °C	75 °C	80 °C	x	x	x	x
			Life-time	> 100,000 h	68,000 h	50,000 h	35,000 h	x	x	x	x
PC 1x54 T5 PRO Ip	T5	1x54 W	tc	60 °C	70 °C	75 °C	80 °C	x	x	x	x
			Life-time	> 100,000 h	60,000 h	40,000 h	30,000 h	x	x	x	x
PC 1x80 T5 PRO Ip	T5	1x80 W	tc	60 °C	70 °C	75 °C	80 °C	x	x	x	x
			Life-time	100,000 h	70,000 h	50,000 h	30,000 h	x	x	x	x
	TC-L	1x55 W	tc	55 °C	65 °C	70 °C	75 °C	80 °C	x	x	x
			Life-time	> 100,000 h	> 100,000 h	80,000 h	60,000 h	40,000 h	x	x	x
PC 2x14-35 T5 PRO Ip	T5	2x14 W	tc	55 °C	60 °C	65 °C	70 °C	75 °C	80 °C	85 °C	x
			Life-time	> 100,000 h	> 100,000 h	> 100,000 h	> 100,000 h	75,000 h	50,000 h	35,000 h	x
		2x21 W	tc	55 °C	65 °C	70 °C	75 °C	80 °C	85 °C	x	x
			Life-time	> 100,000 h	> 100,000 h	95,000 h	70,000 h	50,000 h	35,000 h	x	x
		2x28 W	tc	60 °C	70 °C	75 °C	80 °C	x	x	x	x
			Life-time	> 100,000 h	90,000 h	60,000 h	45,000 h	x	x	x	x
		2x35 W	tc	65 °C	75 °C	80 °C	x	x	x	x	x
			Life-time	> 100,000 h	55,000 h	40,000 h	x	x	x	x	x
PC 2x24 T5 PRO Ip	T5	2x24 W	tc	55 °C	65 °C	70 °C	75 °C	80 °C	85 °C	x	x
			Life-time	> 100,000 h	> 100,000 h	79,000 h	55,000 h	40,000 h	30,000 h	x	x
	TC-L	2x24 W	tc	55 °C	65 °C	70 °C	75 °C	80 °C	85 °C	x	x
			Life-time	> 100,000 h	> 100,000 h	79,000 h	55,000 h	40,000 h	30,000 h	x	x
PC 2x39 T5 PRO Ip	T5	2x39 W	tc	60 °C	70 °C	75 °C	80 °C	x	x	x	x
			Life-time	> 100,000 h	60,000 h	45,000 h	30,000 h	x	x	x	x
PC 2x49 T5 PRO Ip	T5	2x49 W	tc	65 °C	75 °C	80 °C	x	x	x	x	x
			Life-time	86,000 h	50,000 h	30,000 h	x	x	x	x	x
PC 2x54 T5 PRO Ip	T5	2x54 W	tc	70 °C	75 °C	80 °C	x	x	x	x	x
			Life-time	75,000 h	50,000 h	35,000 h	x	x	x	x	x
PC 2x80 T5 PRO Ip	T5	2x80 W	tc	70 °C	80 °C	85 °C	x	x	x	x	x
			Life-time	80,000 h	50,000 h	35,000 h	x	x	x	x	x
PC 2x55 TCL PRO Ip	TC-L	2x55 W	tc	70 °C	75 °C	80 °C	x	x	x	x	x
			Life-time	75,000 h	50,000 h	35,000 h	x	x	x	x	x
PC 3/4x14 T5 PRO Ip	T5	3x14 W	tc	55 °C	65 °C	70 °C	75 °C	x	x	x	x
			Life-time	75,000 h	75,000 h	55,000 h	40,000 h	x	x	x	x
		4x14 W	tc	60 °C	70 °C	75 °C	x	x	x	x	x
			Life-time	75,000 h	55,000 h	40,000 h	x	x	x	x	x
PC 3/4x24 T5 PRO Ip	T5	3x24 W	tc	60 °C	70 °C	75 °C	80 °C	x	x	x	x
			Life-time	75,000 h	75,000 h	50,000 h	35,000 h	x	x	x	x
	TC-L	3x24 W	tc	60 °C	70 °C	75 °C	80 °C	x	x	x	x
			Life-time	75,000 h	75,000 h	50,000 h	35,000 h	x	x	x	x
	T5	4x24 W	tc	65 °C	75 °C	80 °C	x	x	x	x	x
			Life-time	75,000 h	50,000 h	35,000 h	x	x	x	x	x
TC-L	4x24 W	tc	65 °C	75 °C	80 °C	x	x	x	x	x	
		Life-time	75,000 h	50,000 h	35,000 h	x	x	x	x	x	

x = not permitted

Maximum loading of automatic circuit breakers

Automatic circuit breaker type	C10	C13	C16	C20	B10	B13	B16	B20	Inrush current	
Installation Ø	1.5 mm ²	1.5 mm ²	1.5 mm ²	2.5 mm ²	1.5 mm ²	1.5 mm ²	1.5 mm ²	2.5 mm ²	I _{max}	Pulse
PC 1x14-35 T5 PRO Ip	32	44	50	64	16	22	25	32	13.0 A	211 µs
PC 1x24 T5 PRO Ip	28	40	44	58	14	20	22	29	13.2 A	212 µs
PC 1x39 T5 PRO Ip	28	40	44	58	14	20	22	29	14.0 A	213 µs
PC 1x49 T5 PRO Ip	28	40	44	58	14	20	22	29	17.3 A	174 µs
PC 1x54 T5 PRO Ip	28	40	44	58	14	20	22	29	18.0 A	171 µs
PC 1x80 T5 PRO Ip	18	27	30	36	9	14	15	18	20.5 A	243 µs
PC 2x14-35 T5 PRO Ip	18	24	28	34	9	12	14	17	21.3 A	225 µs
PC 2x24 T5 PRO Ip	28	40	44	58	14	20	22	29	17.3 A	173 µs
PC 2x39 T5 PRO Ip	18	27	30	36	9	14	15	18	33.8 A	165 µs
PC 2x49 T5 PRO Ip	14	16	24	28	7	8	12	14	37.4 A	190 µs
PC 2x54 T5 PRO Ip	14	16	24	28	7	8	12	14	37.7 A	182 µs
PC 2x80 T5 PRO Ip	10	13	16	20	5	7	8	10	34.2 A	277 µs
PC 2x55 TCL PRO Ip	14	16	24	28	7	8	12	14	37.4 A	190 µs
PC 3/4x14 T5 PRO Ip	30	39	49	61	16	22	27	33	21.5 A	230 µs
PC 3/4x24 T5 PRO Ip	14	18	22	28	7	9	11	14	33.9 A	207 µs

Wiring advice

The lead length is dependant on the capacitance of the cable.

For safety reasons, the PC T5 PRO Ip must only be earthed in the case of a safety class 1 luminaire.

Earthing is not required for the device to operate. Connection to earth reduces radio interference.

With standard solid wire 0.5/0.75 mm² the capacitance of the lead is 30–80 pF/m. This value is influenced by the way the wiring is made.

- keep lamp wires short
- lamp connection with multi-lamp ballasts should be made with symmetrical wiring
- lamp leads marked with * should be separated as much as possible from other lamp leads

Ballast	Terminal	Maximum capacitance allowed					
		Cold		Hot			
Type							
PC 1x... T5 PRO Ip		13, 14		15, 16		200 pF	100 pF
PC 2x14-35/49/80 T5 PRO Ip		12, 13, 14		10, 11, 15, 16		200 pF	100 pF
PC 2x49 T5 PRO Ip		12, 13, 14		10, 11, 15, 16		200 pF	100 pF
PC 2x24 T5 PRO Ip		11, 12, 13, 14		15, 16		200 pF	100 pF
PC 2x39 T5 PRO Ip		11, 12, 13, 14		15, 16		200 pF	100 pF
PC 2x54 T5 PRO Ip		11, 12, 13, 14		15, 16		200 pF	100 pF
PC 2x80 T5 PRO Ip		11, 12, 13, 14		15, 16		200 pF	100 pF
PC 2x55 TCL PRO Ip		11, 12, 13, 14		15, 16		200 pF	100 pF
PC 3x... T5 PRO Ip		9, 10, 11, 12, 13, 14		15, 16		200 pF	100 pF
PC 4x... T5 PRO Ip		6, 7, 9, 10, 11, 12, 13, 14		15, 16		200 pF	100 pF

To avoid the damage of the control gear, the wiring must be protected against short circuits to earth (sharp edged metal parts, metal cable clips, louver, etc.)

Installation instructions

IDC interface

- solid wire with a cross section of 0.5 mm² according to the specification from WAGO

Horizontal interface

- solid wire with a cross section of 0.5–0.75 mm² according to the specification from WAGO
- solid wire with a cross section of 1.0 mm² with an insulation diameter up to 2.5 mm
- strip 9 mm of insulation from the cables to ensure perfect operation of the push terminals
- Loosen wire through twisting and pulling

wire preparation:
0.5 – 0.75 mm²

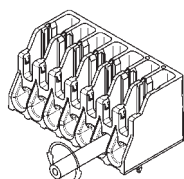
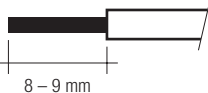

Loosen wire through twisting and pulling

Side fixing feature

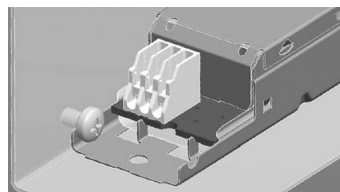



Screw M4, screw head diameter 8–10 mm

Defective lamp

If a lamp is defective, the ballast switches off and goes into standby. There is an automatic restart once the lamp has been changed.

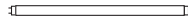
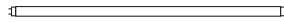
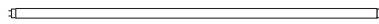
T5 lamp information

	wattage	length
	14/24 W	549 mm
	21/39 W	849 mm
	28/54 W	1149 mm
	35/49/80 W	1449 mm

TC-L lamp information

	wattage	length
	24 W	309 mm
	55 W	535 mm

RFI

Tridonic ballasts are RFI protected in accordance with EN 55015. To operate the luminaire correctly and to minimise RFI we recommend the following instructions:

- Connection to the lamps of the "hot leads" must be kept as short as possible (marked with *)
- Mains leads should be kept apart from lamp leads (ideally 5–10 cm distance)
- Do not run mains leads adjacent to the electronic ballast
- Twist the lamp leads
- Keep the distance of lamp leads from the metal work as large as possible
- Connect functional earth to the ballast, either over the terminal or over the mounting screw of the ballast
- Mains wiring to be twisted when through wiring
- Keep the mains leads inside the luminaire as short as possible

Insulation and electric strength testing of luminaires

Electronic devices can be damaged by high voltage. This has to be considered during the routine testing of the luminaires in production.

According to IEC 60598-1 Annex Q (informative only!) or ENEC 303-Annex A, each luminaire should be submitted to an insulation test with 500 V_{DC} for 1 second. This test voltage should be connected between the interconnected phase and neutral terminals and the earth terminal.

The insulation resistance must be at least 2 MΩ.

As an alternative, IEC 60598-1 Annex Q describes a test of the electrical strength with 1500 V_{AC} (or 1.414 x 1500 V_{DC}). To avoid damage to the electronic devices this test must not be conducted.

Additional information

Additional technical information at www.tridonic.com → Technical Data

Guarantee conditions at www.tridonic.com → Services

Life-time declarations are informative and represent no warranty claim. No warranty if device was opened.

Wiring diagrams

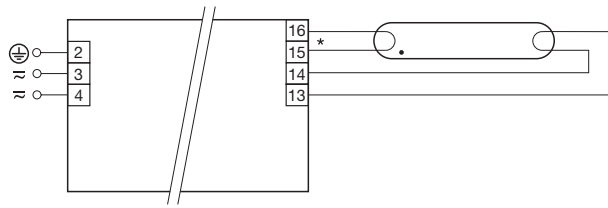

* leads 15, 16 max. 1.0 m (< 100 pF)
leads 13, 14 max. 2.0 m (< 200 pF)
For luminaires of protection class I: Earthing via ECG casing or earth terminal (according to IEC 60598)
For luminaires of protection class II: No earthing required

PC 1x... T5 PRO Ip

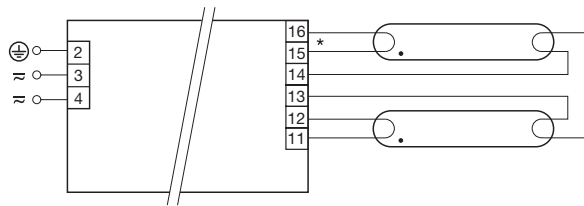

* leads 15, 16 max. 1.0 m (< 100 pF)
leads 11, 12, 13, 14 max. 2.0 m (< 200 pF)
For luminaires of protection class I: Earthing via ECG casing or earth terminal (according to IEC 60598)
For luminaires of protection class II: No earthing required

PC 2x24 T5 PRO Ip
PC 2x39 T5 PRO Ip
PC 2x54 T5 PRO Ip
PC 2x80 T5 PRO Ip
PC 2x55 TCL PRO Ip

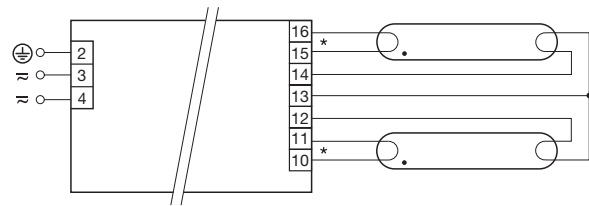

* leads 10, 11, 15, 16 max. 1.0 m (< 100 pF)
leads 12, 13, 14 max. 2.0 m (< 200 pF)
For luminaires of protection class I: Earthing via ECG casing or earth terminal (according to IEC 60598)
For luminaires of protection class II: No earthing required

PC 2x14-35 T5 PRO Ip
PC 2x49 T5 PRO Ip

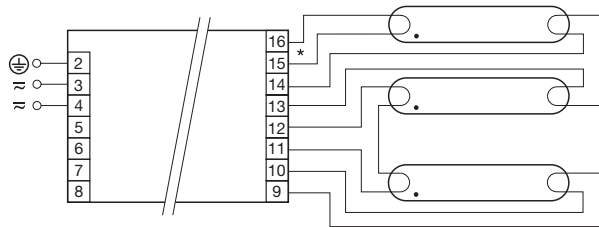

* leads 15, 16 max. 1.0 m (< 100 pF)
leads 9, 10, 11, 12, 13, 14 max. 2.0 m (< 200 pF)
For luminaires of protection class I: Earthing via ECG casing or earth terminal (according to IEC 60598)
For luminaires of protection class II: No earthing required

PC 3x... T5 PRO Ip

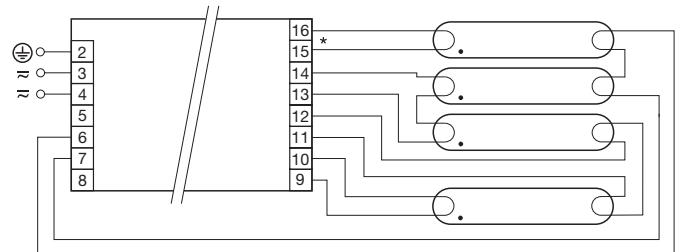

* leads 15, 16 max. 1.0 m (< 100 pF)
leads 6, 7, 9, 10, 11, 12, 13, 14 max. 2.0 m (< 200 pF)
For luminaires of protection class I: Earthing via ECG casing or earth terminal (according to IEC 60598)
For luminaires of protection class II: No earthing required

PC 4x... T5 PRO Ip